

## Product Features

This powerful floodlight, ranging from 100 to 900 watts, is ideal for illuminating your building's exterior. Choose from mono color for a classic look, or personalize your facade with RGB or RGBW options. Additionally, Dali dimming allows for precise control over the light's intensity. For peace of mind, we offer a comprehensive 5-year replacement warranty.



## PHYSICAL

Body	Die-Cast Aluminium
Dimensions	W200*H265*L649m
Finish	Powdear Coating
IP Rating	IP67

## OPTICAL

Lamp	LED
Cover	Clear Tempered glass
Beam Angle	8°/10°/15°/45°/60°/80°/ 10*30°/20*45°/15*65°/15*45°
Color Temp.	Mono Color, RGB, RGBW
LED Chip	CREE   OSRAM
Lumen Output	+85lm / W
Color rendering i(Ra):	>82
Power factor (PF):	>0.9

## ELECTRICAL

Power	300W
Controller	Switch   Dali   DMX
Input voltage	220V -240V
Lamp life	50,000 h
Ambient Temp.	-25°C ~ 50°C
Ambient Humidity	-25% ~ +60%
PCB	Excellent heat conductivity aluminum coefficient of heat conductivity ≥ 2.0w/mk
PCB Voltage protection	Reverse voltage protection
PCB Current Stabilization	Integrated current stabilization system

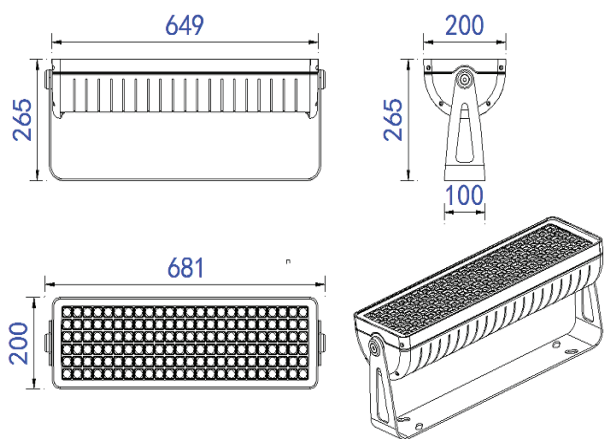

Ref.	Wattage	Voltage	Color Temp	Beam	Control
HD-S23N300	300W	110V - 240V (Integral)	Mono Color	3° / 5° / 8° / 10° / 15° / 45° / 60° / 80° / 10*30° / 20*45° / 15*65° / 15*45°	On/Off
HD-S23N300R3	300W	110V - 240V (Integral)	RGB	20° / 30° / 60° / 80° / 15*45°	DMX
HD-S23N300R4	300W	110V - 240V (Integral)	RGBW	20° / 30° / 60° / 80° / 15*45°	DMX